

## Zubadan

Model Name			PUHZ-SHW80VHA	PUHZ-SHW112VHA	PUHZ-SHW112YHA	
Power supply (phase, cycle, voltage)			1φ, 230V, 50Hz	1φ, 230V, 50Hz	3φ, 400V, 50Hz	
Max. current	A		29.5	35.0	13.0	
Breaker size		A	32	40	16	
Outer casing			Galvanized plate	Galvanized plate	Galvanized plate	
External finish			Munsell 3Y 7.8/1.1	Munsell 3Y 7.8/1.1	Munsell 3Y 7.8/1.1	
Refrigerant control			Linear expansion valve	Linear expansion valve	Linear expansion valve	
Compressor			Hermetic scroll	Hermetic scroll	Hermetic scroll	
Model			ANB33FJMMT	ANB33FJMMT	ANB33FJLMT	
Motor output	kW		2.5	2.5	2.5	
Start type			Inverter	Inverter	Inverter	
Protection devices			HP switch LP switch Discharge thermo Comp. Surface thermo	HP switch LP switch Discharge thermo Comp. Surface thermo	HP switch LP switch Discharge thermo Comp. Surface thermo	
Oil (Model)	L		1.40 (FV50S)	1.40 (FV50S)	1.40 (FV50S)	
Crankcase heater		W	-	-	-	
Heat exchanger		Air	Plate fin coil	Plate fin coil	Plate fin coil	
		Water	-	-	-	
Fan		Fan(drive) x No.		Propeller fan ×2	Propeller fan ×2	Propeller fan ×2
		Fan motor output	kW	0.074 ×2	0.074 ×2	0.074 ×2
		Air flow	m <sup>3</sup> /min (CFM)	100 (3,350)	100 (3,350)	100 (3,350)
Defrost method			Reverse cycle	Reverse cycle	Reverse cycle	
Noise level (SPL)		Heating	dB(A)	51	52	52
		Cooling	dB(A)	50	51	51
Noise level (PWL)		Heating	dB(A)	69	70	70
Dimensions		Width	mm(in.)	950 (37-3/8)	950 (37-3/8)	950 (37-3/8)
		Depth	mm(in.)	330+30 (13+1-3/16)	330+30 (13+1-3/16)	330+30 (13+1-3/16)
		Height	mm(in.)	1350 (53-1/8)	1350 (53-1/8)	1350 (53-1/8)
Weight		kg(lbs)	120 (265)	120 (265)	134 (296)	
Refrigerant			R410A	R410A	R410A	
		Quantity	kg(lbs)	5.5 (12.1)	5.5 (12.1)	5.5 (12.1)
Pipe size O.D.		Liquid	mm(in)	9.52 (3/8)	9.52 (3/8)	9.52 (3/8)
		Gas	mm(in)	15.88 (5/8)	15.88 (5/8)	15.88 (5/8)
Connection method			Flared	Flared	Flared	
Between the indoor & outdoor unit		Height difference	m	Max. 30	Max. 30	Max. 30
		Piping length	m	Max. 75	Max. 75	Max. 75
Guaranteed operating range (Outdoor)		Heating	°C	-25 ~ +21	-25 ~ +21	-25 ~ +21
		DHW	°C	-25 ~ +35	-25 ~ +35	-25 ~ +35
		Cooling	°C	-5 ~ +46	-5 ~ +46	-5 ~ +46
Outlet water temp. (Max in heating, Min in cooling)		Heating	°C	+60	+60	+60
		Cooling	°C	+5	+5	+5
Nominal return water temperature range		Heating	°C	+10 ~ +59	+10 ~ +59	+10 ~ +59
		Cooling	°C	+8 ~ +28	+8 ~ +28	+8 ~ +28
Water flow rate range		L/min	10.2 ~ 22.9	14.4 ~ 32.1	14.4 ~ 32.1	

## ■ Zubadan

Model name			PUHZ-SHW80VHA	PUHZ-SHW112VHA
Nominal water flow rate (Heating mode)		L/min	22.90	32.10
Heating (A7/W35)	Capacity	kW	8.00	11.20
	COP		4.65	4.46
	Power input	kW	1.72	2.51
Heating (A2/W35)	Capacity	kW	8.00	11.20
	COP		3.55	3.34
	Power input	kW	2.25	3.35
Pressure difference (water circuit)		kPa	-	-
Heating pump input (based on EN14511)		kW	-	-
Nominal water flow rate (Cooling mode)		L/min	20.40	28.70
Cooling (A35/W7)	Capacity	kW	7.10	10.00
	EER (COP)		3.31	2.83
	Power input	kW	2.15	3.53
Cooling (A35/W18)	Capacity	kW	7.10	10.00
	EER (COP)		4.52	4.74
	Power input	kW	1.57	2.11
Pressure difference (water circuit)		kPa	-	-
Cooling pump input (based on EN14511)		kW	-	-
Recommended plate heat exchanger			ACH70-40	ACH70-40

The table shows performance data obtained when a plate heat exchanger is connected.

Model name			PUHZ-SHW112YHA	PUHZ-SHW140YHA
Nominal water flow rate (Heating mode)		L/min	32.10	40.10
Heating (A7/W35)	Capacity	kW	11.20	14.00
	COP		4.46	4.22
	Power input	kW	2.51	3.32
Heating (A2/W35)	Capacity	kW	11.20	14.00
	COP		3.34	2.96
	Power input	kW	3.35	4.73
Pressure difference (water circuit)		kPa	-	-
Heating pump input (based on EN14511)		kW	-	-
Nominal water flow rate (Cooling mode)		L/min	28.70	35.80
Cooling (A35/W7)	Capacity	kW	10.00	12.50
	EER (COP)		2.83	2.17
	Power input	kW	3.53	5.76
Cooling (A35/W18)	Capacity	kW	10.00	12.50
	EER (COP)		4.74	4.26
	Power input	kW	2.11	2.93
Pressure difference (water circuit)		kPa	-	-
Cooling pump input (based on EN14511)		kW	-	-
Recommended plate heat exchanger			ACH70-40	ACH70-40

The table shows performance data obtained when a plate heat exchanger is connected.

## (2) Split-type units

### ■ Power inverter

#### PUHZ-SW40/50VHA

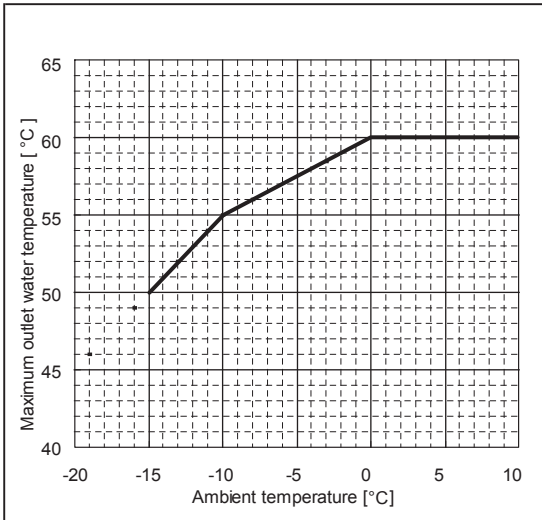

#### PUHZ-SW75VHA

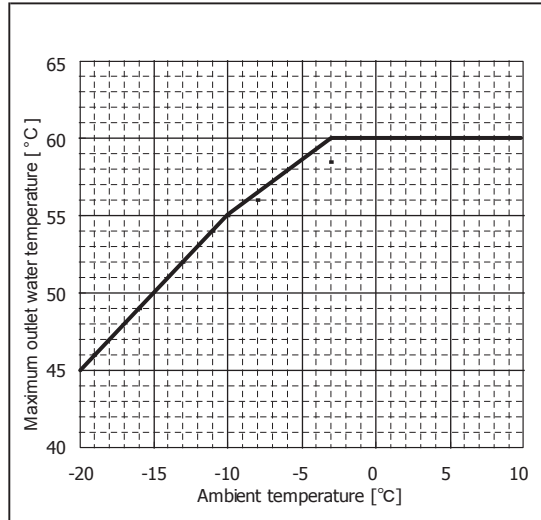

#### PUHZ-SW100/120VHA

#### PUHZ-SW100/120YHA

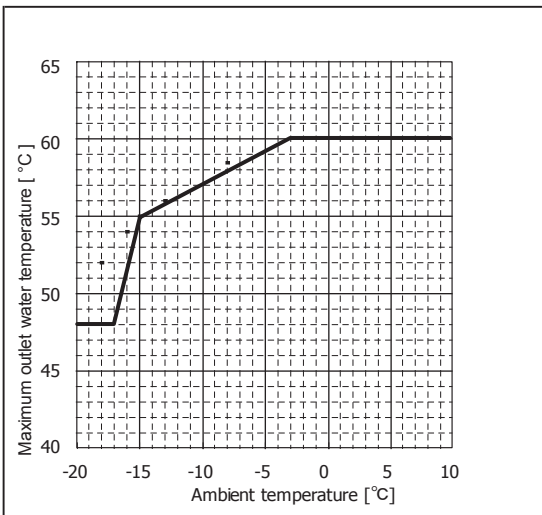

#### PUHZ-RP200/250YKA

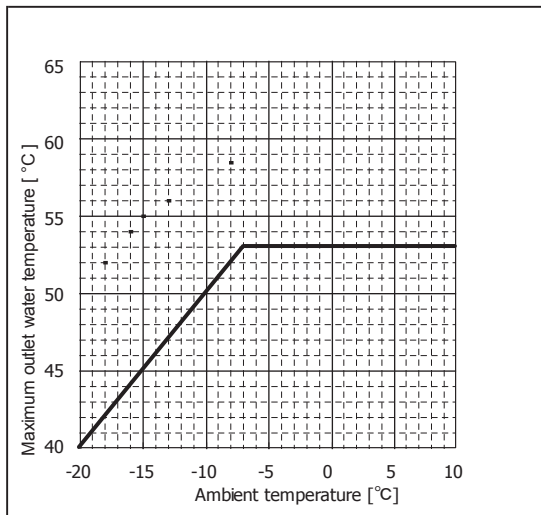

### ■ Zubadan

#### PUHZ-SHW80/112VHA

#### PUHZ-SHW112/140YHA

#### PUHZ-SHW230YKA

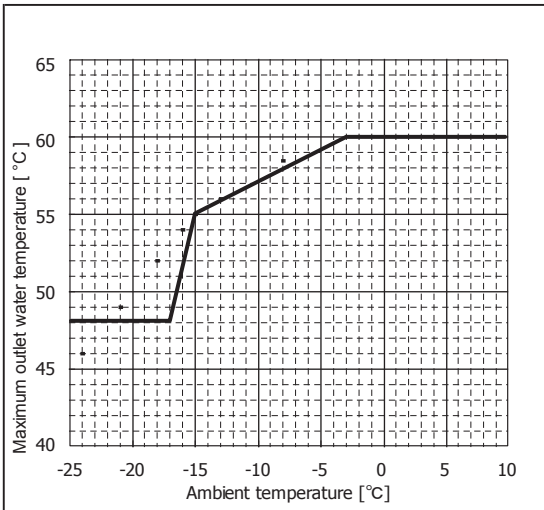

■ PUAZ-SHW80/112VHA  
 PUAZ-SHW112/140YHA

Unit : mm

Outdoor unit

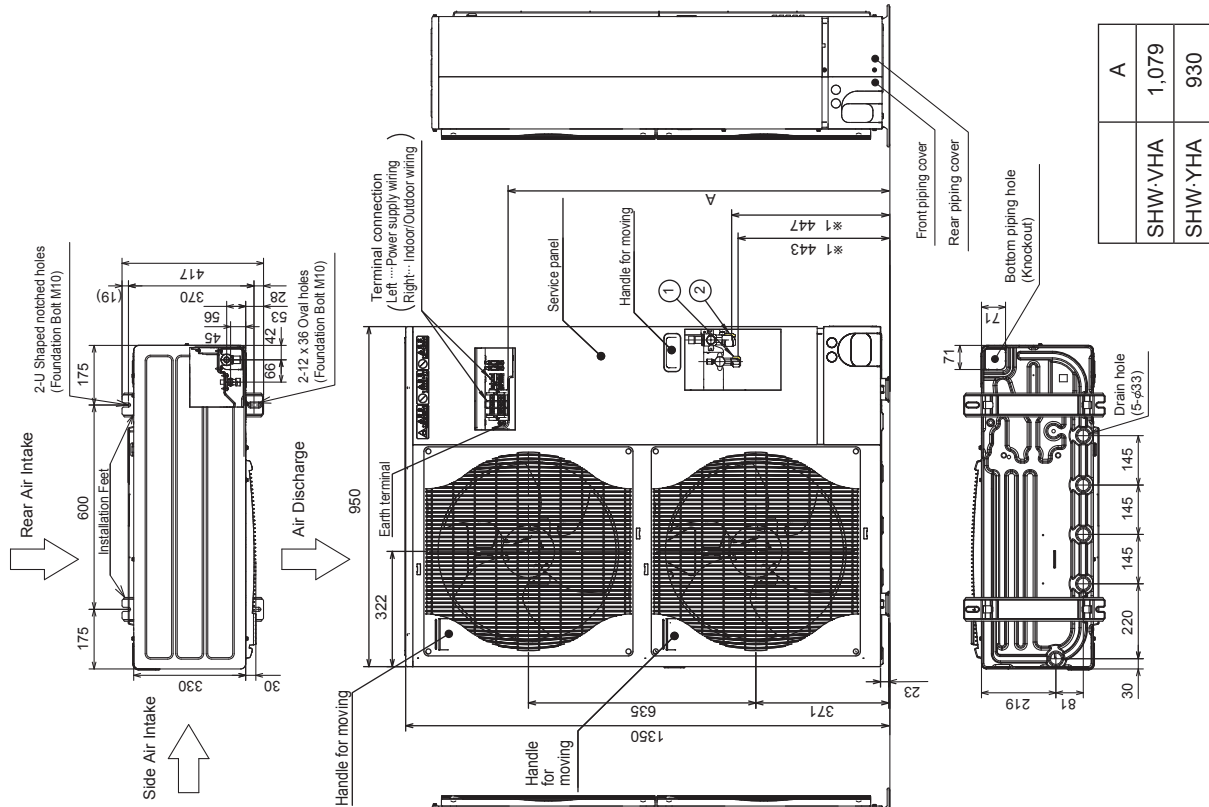

A	
SHW-VHA	1,079
SHW-YHA	930

### 4 PIPING-WIRING DIRECTIONS

Piping and wiring connections can be made from 4 directions: front, right, rear and below.

### 3 FOUNDATION BOLTS

Please secure the unit firmly with 4 foundation (M10) bolts. (Bolts and washers must be purchased locally).

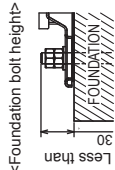

### 2 SERVICE SPACE

Dimensions of space needed for service access are shown in the below diagram.

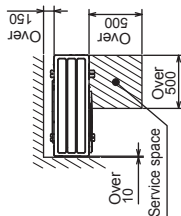

### 1 FREE SPACE (Around the unit)

The diagram below shows a basic example. Explanation of particular details is given in the installation manuals etc.

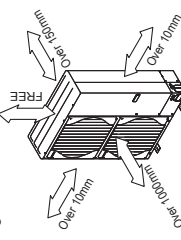

### Example of Notes

- ①...Refrigerant GAS pipe connection (FLARE) φ15.88(5/8 inch)
- ②...Refrigerant LIQUID pipe connection (FLARE) φ9.52(3/8 inch)
- \*1...Indication of STOP VALVE connection location.

### Piping Knockout Hole Details

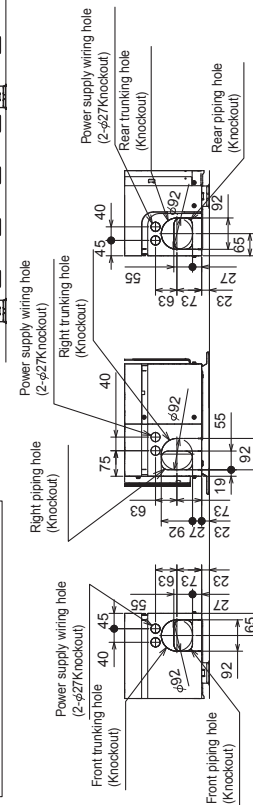

Outdoor unit

■ PUAZ-SHW80VHA

Water outlet temperature[°C]		25		35		40		45		50		55		60	
Ambient temperature[°C]		Capacity	COP	Capacity	COP	Capacity	COP	Capacity	COP	Capacity	COP	Capacity	COP	Capacity	COP
Max	(INJ) -20	-	-	7.47	2.25	7.47	2.01	7.47	1.78	-	-	-	-	-	-
	(INJ) -15	-	-	10.11	2.39	9.89	2.11	9.66	1.83	9.44	1.58	9.22	1.34	-	-
	(INJ) -10	11.44	3.12	10.89	2.67	10.61	2.36	10.33	2.05	10.09	1.78	9.85	1.51	-	-
	(INJ) -7	11.97	3.25	11.35	2.84	11.04	2.51	10.73	2.19	10.48	1.90	10.22	1.62	-	-
	(INJ) 2	12.88	3.49	12.11	3.22	11.73	2.94	11.35	2.67	11.09	2.32	10.84	1.98	10.37	1.64
	7	13.17	4.80	12.36	4.34	11.95	3.88	11.55	3.42	11.17	3.04	10.80	2.66	10.42	2.28
	12	15.08	5.45	14.26	4.93	13.70	4.37	13.14	3.80	12.71	3.38	12.29	2.96	11.89	2.62
	15	16.12	5.74	15.53	5.33	14.82	4.68	14.10	4.03	13.64	3.58	13.18	3.14	12.77	2.82
	20	17.51	6.10	16.60	5.66	16.15	5.03	15.69	4.41	15.18	3.92	14.67	3.44	14.25	2.98
	Nominal	(INJ) -20	-	-	7.47	2.25	7.47	2.01	7.47	1.78	-	-	-	-	-
(INJ) -15		-	-	8.00	2.52	8.00	2.20	8.00	1.88	8.00	1.63	8.00	1.37	-	-
(INJ) -10		8.00	3.40	8.00	2.90	8.00	2.56	8.00	2.21	8.00	1.94	8.00	1.67	-	-
(INJ) -7		8.00	3.63	8.00	3.13	8.00	2.77	8.00	2.41	8.00	2.13	8.00	1.85	-	-
(INJ) 2		8.06	4.36	8.00	3.55	8.00	3.20	8.00	2.85	8.00	2.47	8.00	2.09	8.00	1.71
7		9.05	5.21	8.00	4.65	8.00	4.04	8.00	3.42	8.00	3.08	8.00	2.73	8.00	2.38
12		10.57	5.77	9.23	5.42	9.23	4.75	9.23	4.07	9.23	3.60	9.23	3.14	9.23	2.68
15		11.27	6.22	10.05	5.94	10.05	5.22	10.05	4.50	10.05	3.95	10.05	3.41	10.05	2.88
20		12.37	6.76	10.85	6.43	10.85	5.68	10.85	4.92	10.85	4.29	10.85	3.67	10.85	3.07
Mid		(INJ) -20	-	-	5.98	2.13	5.98	1.94	5.98	1.74	-	-	-	-	-
	(INJ) -15	-	-	6.40	2.53	6.40	2.28	6.40	2.03	6.40	1.76	6.40	1.48	-	-
	(INJ) -10	6.40	3.39	6.40	2.94	6.40	2.62	6.40	2.29	6.40	1.99	6.40	1.69	-	-
	(INJ) -7	6.40	3.65	6.40	3.18	6.40	2.81	6.40	2.44	6.40	2.12	6.40	1.81	-	-
	(INJ) 2	8.06	4.36	6.40	3.96	6.40	3.52	6.40	3.07	6.40	2.69	6.40	2.30	6.40	1.72
	7	9.05	5.21	6.40	4.77	6.40	4.22	6.40	3.67	6.40	3.20	6.40	2.74	6.40	2.37
	12	10.57	5.77	7.39	5.60	7.39	4.93	7.39	4.26	7.39	3.72	7.39	3.18	7.39	2.65
	15	11.27	6.22	8.04	6.15	8.04	5.40	8.04	4.65	8.04	4.06	8.04	3.47	8.04	2.83
	20	12.37	6.76	10.11	5.99	9.81	5.27	9.50	4.56	9.12	4.00	8.74	3.43	8.68	3.01
	Min	-20	-	-	-	-	-	-	-	-	-	-	-	-	-
-15		-	-	-	-	-	-	-	-	-	-	-	-	-	-
-10		-	-	-	-	-	-	-	-	-	-	-	-	-	-
-7		5.99	3.61	4.93	2.85	4.73	2.49	4.53	2.13	4.34	1.88	4.14	1.63	-	-
(INJ) 2		8.06	4.36	5.76	3.71	5.50	3.23	5.25	2.75	4.99	2.41	4.73	2.07	-	-
7		9.05	5.21	5.56	4.44	5.31	3.86	5.07	3.27	4.82	2.87	4.57	2.46	-	-
12		10.57	5.77	4.41	4.95	4.22	4.29	4.03	3.63	3.83	3.18	3.63	2.73	-	-
15		11.27	6.22	4.80	5.37	4.62	4.68	4.44	3.98	4.22	3.49	4.00	2.99	-	-
20		12.37	6.76	10.11	5.99	9.81	5.27	9.50	4.56	9.12	4.00	8.74	3.43	-	-

■ PUAZ-SHW112Y/VHA

Water outlet temperature[°C]		25		35		40		45		50		55		60	
Ambient temperature[°C]		Capacity	COP	Capacity	COP	Capacity	COP	Capacity	COP	Capacity	COP	Capacity	COP	Capacity	COP
Max	(INJ) -20	-	-	10.46	2.14	10.46	1.93	10.46	1.73	-	-	-	-	-	-
	(INJ) -15	-	-	13.59	2.17	13.39	1.97	13.19	1.77	13.05	1.54	12.90	1.31	-	-
	(INJ) -10	14.80	2.69	14.42	2.40	14.22	2.15	14.03	1.91	13.94	1.69	13.85	1.47	-	-
	(INJ) -7	15.28	2.83	14.91	2.54	14.73	2.27	14.54	1.99	14.48	1.78	14.42	1.56	-	-
	(INJ) 2	14.11	3.37	13.46	3.10	13.13	2.81	12.80	2.51	12.50	2.20	12.21	1.88	11.67	1.55
	7	15.66	4.54	14.82	4.04	14.41	3.65	13.99	3.26	13.59	2.87	13.20	2.49	12.81	2.22
	12	18.05	5.06	17.11	4.52	16.46	4.03	15.80	3.54	15.36	3.14	14.93	2.75	14.57	2.46
	15	19.36	5.38	18.63	4.84	17.76	4.27	16.89	3.71	16.43	3.31	15.97	2.91	15.62	2.61
	20	20.70	5.54	19.70	5.06	19.20	4.52	18.70	3.99	18.20	3.58	17.69	3.17	17.38	2.85
	Nominal	(INJ) -20	-	-	10.46	2.14	10.46	1.93	10.46	1.73	-	-	-	-	-
(INJ) -15		-	-	11.20	2.34	11.20	2.08	11.20	1.82	11.20	1.57	11.20	1.33	-	-
(INJ) -10		11.20	3.13	11.20	2.65	11.20	2.33	11.20	2.01	11.20	1.76	11.20	1.50	-	-
(INJ) -7		11.20	3.37	11.20	2.84	11.20	2.48	11.20	2.12	11.20	1.87	11.20	1.61	-	-
(INJ) 2		11.20	3.90	11.20	3.34	11.20	3.02	11.20	2.70	11.20	2.32	11.20	1.94	11.20	1.60
7		11.20	5.03	11.20	4.46	11.20	3.99	11.20	3.51	11.20	3.05	11.20	2.58	11.20	2.28
12		12.93	5.66	12.93	5.01	12.93	4.45	12.93	3.88	12.93	3.40	12.93	2.92	12.93	2.57
15		14.08	5.97	14.08	5.38	14.08	4.75	14.08	4.12	14.08	3.63	14.08	3.14	14.08	2.77
20		15.19	6.54	15.19	5.74	15.19	5.05	15.19	4.36	15.19	3.86	15.19	3.35	15.19	2.96
Mid		(INJ) -20	-	-	8.37	2.23	8.37	2.00	8.37	1.76	-	-	-	-	-
	(INJ) -15	-	-	8.96	2.43	8.96	2.14	8.96	1.84	8.96	1.59	8.96	1.34	-	-
	(INJ) -10	8.96	3.33	8.96	2.83	8.96	2.48	8.96	2.14	8.96	1.87	8.96	1.59	-	-
	(INJ) -7	8.96	3.61	8.96	3.06	8.96	2.69	8.96	2.33	8.96	2.03	8.96	1.74	-	-
	(INJ) 2	8.96	4.22	8.96	3.46	8.96	3.13	8.96	2.81	8.96	2.44	8.96	2.08	8.96	1.68
	7	9.01	5.18	8.96	4.61	8.96	4.06	8.96	3.51	8.96	3.09	8.96	2.66	8.96	2.33
	12	10.51	5.73	10.34	5.28	10.34	4.64	10.34	4.01	10.34	3.53	10.34	3.05	10.34	2.66
	15	11.33	6.17	11.26	5.72	11.26	5.03	11.26	4.34	11.26	3.82	11.26	3.30	11.26	2.89
	20	12.31	6.70	12.15	6.15	12.15	5.41	12.15	4.66	12.15	4.10	12.15	3.55	12.15	3.10
	Min	-20	-	-	-	-	-	-	-	-	-	-	-	-	-
-15		-	-	-	-	-	-	-	-	-	-	-	-	-	-
-10		-	-	-	-	-	-	-	-	-	-	-	-	-	-
-7		5.96	3.59	4.91	2.84	4.71	2.48	4.51	2.12	4.32	1.87	4.12	1.62	-	-
(INJ) 2		8.02	4.37	5.73	3.69	5.48	3.21	5.22	2.73	4.96	2.39	4.70	2.05	-	-
7		9.01	5.18	5.53	4.41	5.29	3.83	5.05	3.25	4.80	2.85	4.55	2.44	-	-
12		10.51	5.73	4.39	4.92	4.20	4.26	4.01	3.61	3.81	3.16	3.61	2.71	-	-
15		11.33	6.17	4.78	5.33	4.60	4.64	4.42	3.95	4.20	3.46	3.98	2.97	-	-
20		12.31	6.70	10.06	5.94	9.76	5.23	9.45	4.52	9.08	3.96	8.70	3.41	-	-

## 5.3 Best COP

### ■ Power inverter

Water outlet temperature[°C ]		35		45		55	
Ambient temperature[°C ]		Capacity	COP	Capacity	COP	Capacity	COP
PUHZ-SW 40VHA(-BS)	-7	3.49	2.85	3.36	2.15	3.24	1.59
	2	3.04	3.58	3.14	2.74	3.18	1.91
		2.85	3.72	2.82	2.87	2.79	2.01
7	3.91	4.82	3.76	3.66	3.65	2.37	
PUHZ-SW 50VHA(-BS)	-7	3.52	2.85	3.39	2.16	3.26	1.60
	2	3.06	3.60	3.16	2.76	3.21	1.92
		2.87	3.74	2.85	2.88	2.82	2.02
7	3.94	4.84	3.79	3.67	3.68	2.38	
PUHZ-SW 75VHA(-BS)	-7	6.16	2.95	5.92	2.26	5.33	1.74
	2	5.11	3.60	4.73	3.05	4.18	2.20
		4.57	3.71	4.23	3.12	3.75	2.27
7	5.64	4.72	5.94	3.65	6.14	2.77	
PUHZ-SW 100V/YHA(-BS)	-7	7.15	2.95	7.35	2.27	7.48	1.62
	2	7.32	3.69	7.17	2.86	6.89	2.08
		6.74	3.88	6.63	2.97	6.42	2.21
7	6.21	4.71	6.35	3.62	6.58	2.71	
PUHZ-SW 120V/YHA(-BS)	-7	8.11	2.92	8.34	2.26	8.56	1.70
	2	7.81	3.67	7.54	2.88	7.32	2.05
		6.82	3.84	6.78	2.97	6.72	2.14
7	9.24	4.65	9.55	3.54	9.89	2.62	

### ■ Zubadan

Water outlet temperature[°C ]		35		45		55	
Ambient temperature[°C ]		Capacity	COP	Capacity	COP	Capacity	COP
PUHZ-SHW 80VHA	-7	7.18	3.20	7.33	2.46	7.40	1.90
	2	7.54	3.68	7.35	3.00	7.21	2.25
		6.82	4.06	6.72	3.15	6.66	2.38
7	6.15	4.82	6.03	3.70	5.79	2.80	
PUHZ-SHW 112V/YHA	-7	7.16	3.18	7.31	2.45	7.38	1.89
	2	7.52	3.66	7.33	2.99	7.19	2.24
		6.80	4.04	6.70	3.13	6.64	2.37
7	6.13	4.80	6.01	3.68	5.77	2.79	
PUHZ-SHW 140YHA	-7	7.14	3.18	7.29	2.44	7.36	1.89
	2	7.50	3.65	7.31	2.98	7.17	2.23
		6.79	4.03	6.69	3.13	6.63	2.36
7	6.12	4.79	6.00	3.67	5.76	2.78	
PUHZ-SHW 230YKA	-7	16.68	2.95	19.41	2.37	20.98	2.06
	2	13.20	3.45	13.04	2.59	12.91	2.19
		12.49	3.55	12.22	2.73	12.00	2.25
7	11.43	4.31	13.94	3.17	15.42	2.42	

## PUHZ-SHW80VHA

MODE	SPL(dB)	LINE
COOLING	50	○—○
HEATING	51	●—●

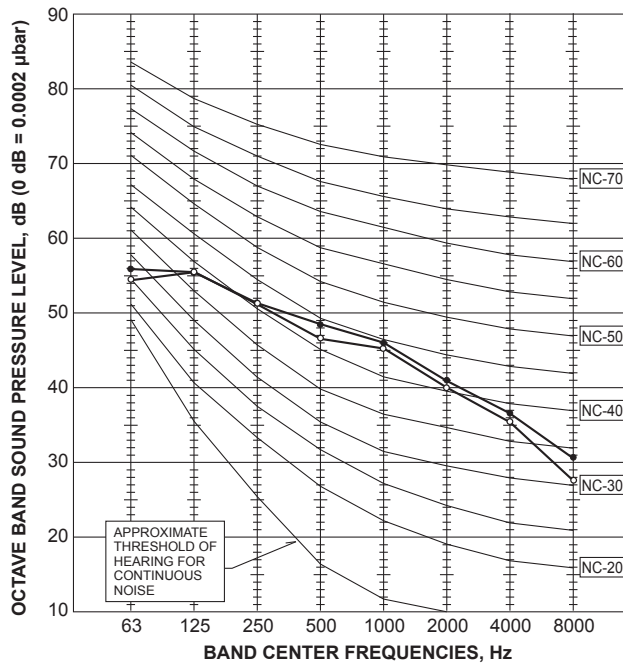

## PUHZ-SHW112VHA PUHZ-SHW112/140YHA

MODE	SPL(dB)	LINE
COOLING	51	○—○
HEATING	52	●—●

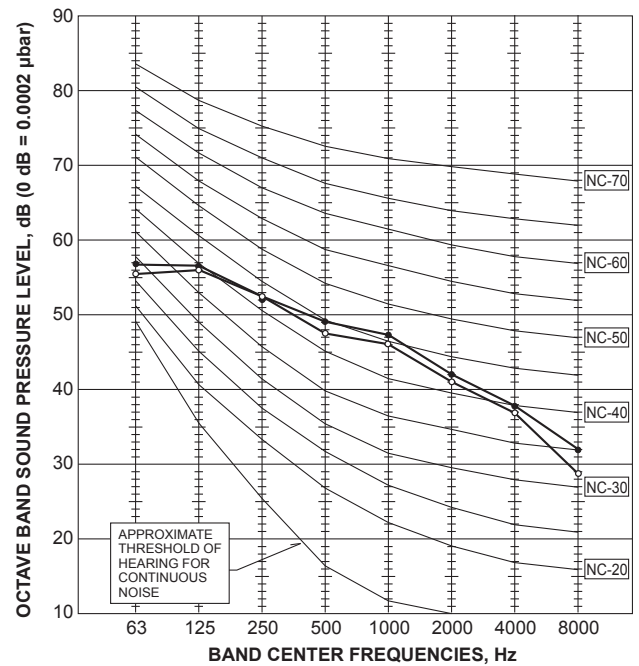

## PUHZ-SHW230YKA

MODE	SPL(dB)	LINE
COOLING	58	○—○
HEATING	59	●—●

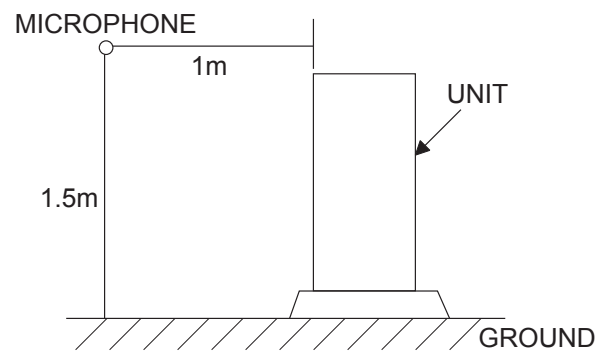
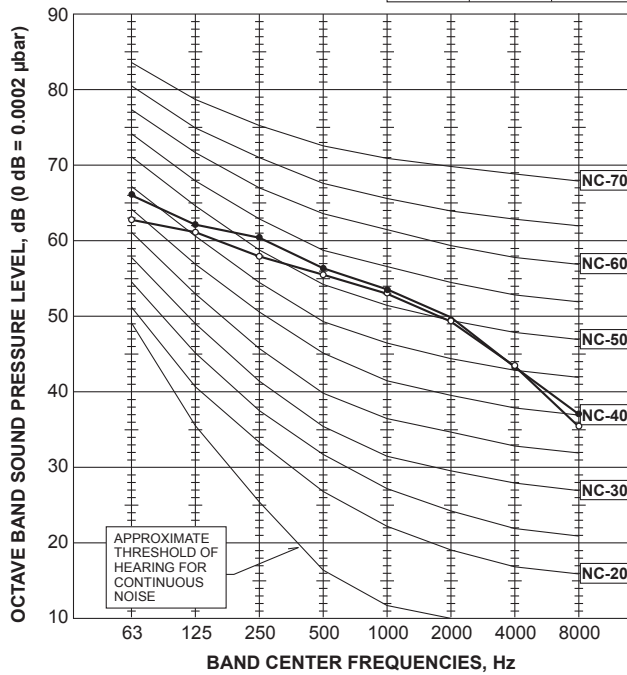

Outdoor unit

## 9.3 Split-type units ( ZUBADAN )

PUHZ-SHW80VHA, PUHZ-SHW112VHA,  
PUHZ-SHW112YHA, PUHZ-SHW140YHA,  
PUHZ-SHW230YKA

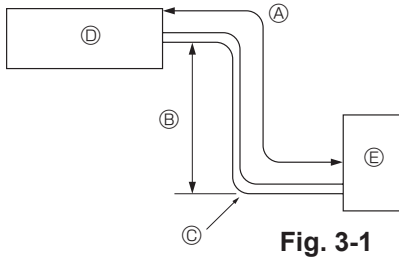

Fig. 3-1

### 9.3.1. Refrigerant pipe (Fig. 3-1)

Check that the difference between the heights of the indoor and outdoor units, the length of refrigerant pipe, and the number of bends in the pipe are within the limits shown below.

Models	Ⓐ Pipe length (one way)	Ⓑ Height difference	Ⓒ Number of bends (one way)
SHW80,112,140	Max. 75 m	Max. 30 m	Max. 15
SHW230	Max. 80 m	Max. 30 m	Max. 15

- Height difference limitations are binding regardless of which unit, indoor or outdoor, is positioned higher.
- ⓐ Indoor unit      ⓑ Outdoor unit

### 9.3.2. Choosing the outdoor unit installation location

- Avoid locations exposed to direct sunlight or other sources of heat.
- Select a location from which noise emitted by the unit will not inconvenience neighbors.
- Select a location permitting easy wiring and pipe access to the power source and indoor unit.
- Avoid locations where combustible gases may leak, be produced, flow, or accumulate.
- Note that water may drain from the unit during operation.
- Select a level location that can bear the weight and vibration of the unit.
- Avoid locations where the unit can be covered by snow. In areas where heavy snow fall is anticipated, special precautions such as raising the installation location or installing a hood on the air intake must be taken to prevent the snow from blocking the air intake or blowing directly against it. This can reduce the airflow and a malfunction may result.
- Avoid locations exposed to oil, steam, or sulfuric gas.
- Use the transportation handles of the outdoor unit to transport the unit. If the unit is carried from the bottom, hands or fingers may be pinched.

### 9.3.3. Outline dimensions (Outdoor unit) (Fig. 3-2)

#### 9.3.4. Ventilation and service space

##### (1) Windy location installation

When installing the outdoor unit on a rooftop or other location unprotected from the wind, situate the air outlet of the unit so that it is not directly exposed to strong winds. Strong wind entering the air outlet may impede the normal airflow and a malfunction may result.

The following shows three examples of precautions against strong winds.

- ① Face the air outlet towards the nearest available wall about 50 cm away from the wall. (Fig. 3-3)
- ② Install an optional air guide if the unit is installed in a location where strong winds from a typhoon, etc. may directly enter the air outlet. (Fig. 3-4)
  - Ⓐ Air protection guide
- ③ Position the unit so that the air outlet blows perpendicularly to the seasonal wind direction, if possible. (Fig. 3-5)
  - Ⓑ Wind direction

##### (2) When installing a single outdoor unit (Refer to the next page)

Minimum dimensions are as follows, except for Max., meaning Maximum dimensions, indicated.

Refer to the figures for each case.

- ① Obstacles at rear only (Fig. 3-6)
- ② Obstacles at rear and above only (Fig. 3-7)
- ③ Obstacles at rear and sides only (Fig. 3-8)
- ④ Obstacles at front only (Fig. 3-9)
  - \*When using the optional air outlet guides, the clearance is 500 mm or more.
- ⑤ Obstacles at front and rear only (Fig. 3-10)
  - \*When using the optional air outlet guides, the clearance is 500 mm or more.
- ⑥ Obstacles at rear, sides, and above only (Fig. 3-11)
  - \*Do not install the optional air outlet guides for upward airflow.

##### (3) When installing multiple outdoor units (Refer to the next page)

Leave 10 mm space or more between the units.

- ① Obstacles at rear only (Fig. 3-12)
- ② Obstacles at rear and above only (Fig. 3-13)
  - \*No more than 3 units must be installed side by side. In addition, leave space as shown.
  - \*Do not install the optional air outlet guides for upward airflow.
- ③ Obstacles at front only (Fig. 3-14)
  - \*When using the optional air outlet guides, the clearance is 1000 mm or more.
- ④ Obstacles at front and rear only (Fig. 3-15)
  - \*When using the optional air outlet guides, the clearance is 1000 mm or more.
- ⑤ Single parallel unit arrangement (Fig. 3-16)
  - \*When using the optional air outlet guides installed for upward airflow, the clearance is 1000 mm or more.
- ⑥ Multiple parallel unit arrangement (Fig. 3-17)
  - \*When using the optional air outlet guides installed for upward airflow, the clearance is 1500 mm or more.
- ⑦ Stacked unit arrangement (Fig. 3-18)
  - \*The units can be stacked up to 2 units high.
  - \*No more than 2 stacked units must be installed side by side. In addition, leave space as shown.

SHW80,112,140

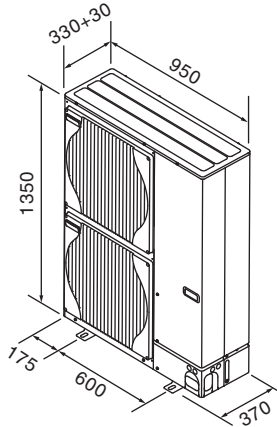

SHW230

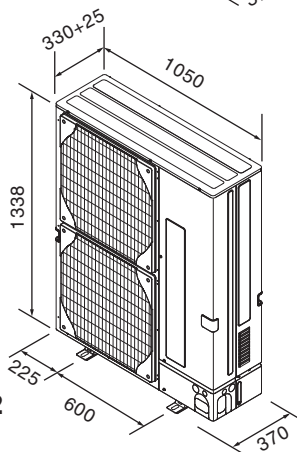

Fig. 3-2

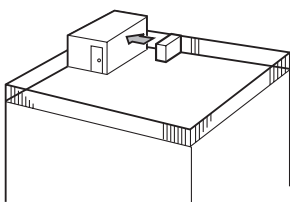

Fig. 3-3

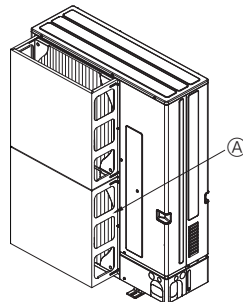

Fig. 3-4

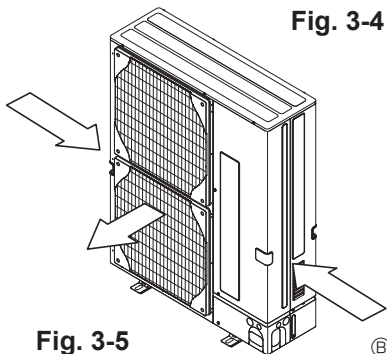
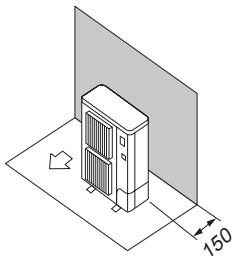

Fig. 3-5



UNIT : mm



**Fig. 3-6**

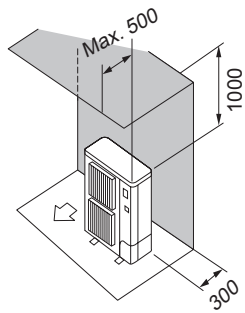

**Fig. 3-7**

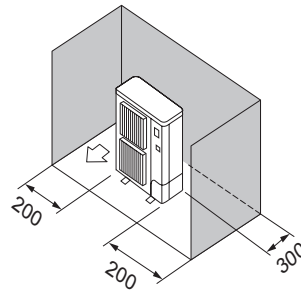

**Fig. 3-8**

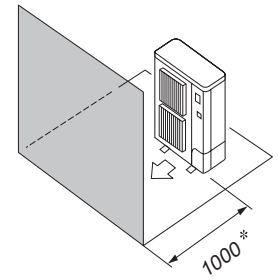

**Fig. 3-9**

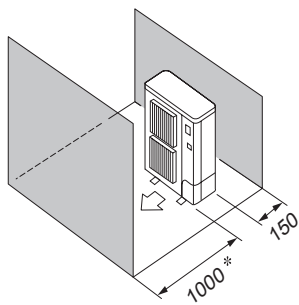

**Fig. 3-10**

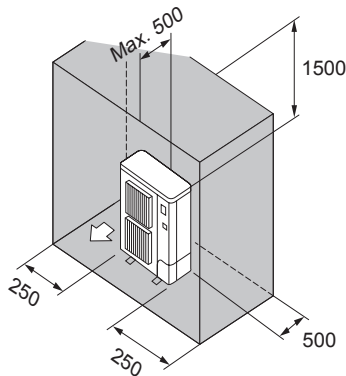

**Fig. 3-11**

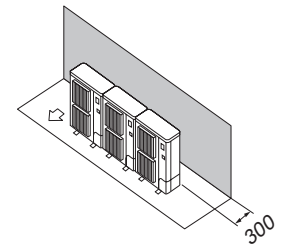

**Fig. 3-12**

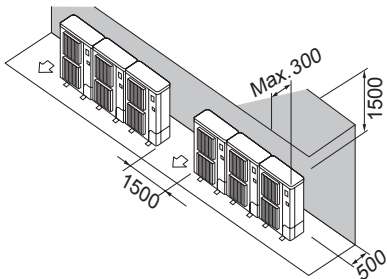

**Fig. 3-13**

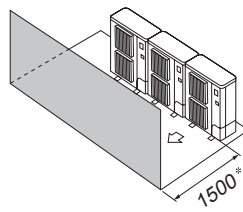

**Fig. 3-14**

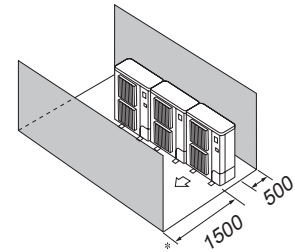

**Fig. 3-15**

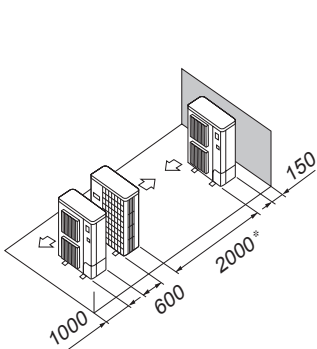

**Fig. 3-16**

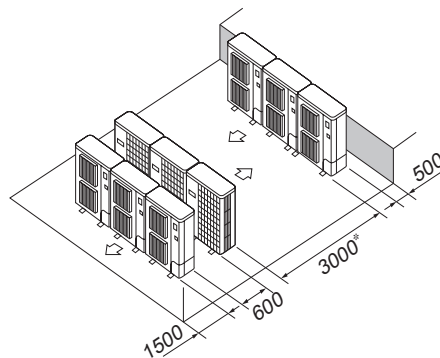

**Fig. 3-17**

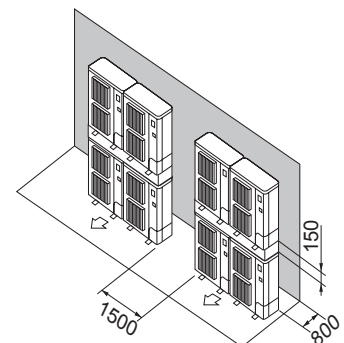

**Fig. 3-18**